



### Optional

- LED/Fluorescent light
- Humidistat
- Motion Sensor
- Speed Controller
- Metal Grille



### HIGHLIGHTS

- Ventilating fan should be ceiling mounted and capable of exhausting air quietly and efficiently
- It comes with a capacitor start motor which is known for its high efficiency and long lasting reliability
- It holds an ETL evaluation and is HVI and ENERGY STAR® certified

### SPECIFICATIONS

Model	OD-9005PB		OD-1109PB		OD-1209PB		OD-1505PB	
Static Pressure in inches w.g.	0.1	0.25	0.1	0.25	0.1	0.25	0.1	0.25
Air Volume (CFM)	90	78	110	95	120	105	150	130
Noise (sones)	0.5		0.9		0.9		0.5	
Fan Watts	25W		30W		30W		35W	
Duct Diameter	6"							
Power Rating (V/Hz)	120/60							

- Housing Size:**  
10-1/2" x 11-3/8" x 7-5/8"  
(267 mm x 289 mm x 194 mm)
- Grille Dimensions:**  
13" x 14"  
(330 mm x 356 mm)
- Fan Weight:**  
10.2 lb

### HOUSING

- Made of rugged 26 GA galvanized steel
- Includes an attachable 6" non-metallic collar with built-in back draft damper
- Double hanger bar mounting brackets that are adjustable up to 24 inch span allows for ideal positioning

### MOTOR / BLOWER

- Plug in permanently lubricated motor — Engineered for continuous operation
- The motor is energy efficient and surpasses the minimum ENERGY STAR® requirements for continuous operation
- Power rating should be 120 volts and 60 Hz
- Fan shall be ETL and cETL listed for tub/shower enclosure when used with GFCI branch circuit
- Motor comes with built-in overload disconnect for safety and longer motor life
- Our Universal series operates at lower RPM's to give you quieter operation
- Polymeric resin Blower for more efficient air transfer and operation

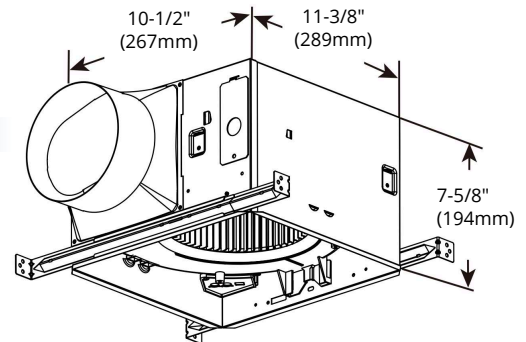

### GRILLE

- The Premium grille is low profile that has elegance and still able to maintain its simplicity
- Made of a rugged polymeric resin that is known for its long life durability
- Comes with torsion spring clips that helps mount grille evenly

### TYPICAL SPECIFICATIONS

- Ceiling ventilator shall have corrosion resistance galvanized steel housing with 4 point mounting capability
- It shall be ducted to a roof vent or wall cap using 6 inch round pipe
- Blower assembly shall be removable, have a centrifugal type blower wheel and permanently lubricated motor designed for continuous operation
- Includes an attachable 6" non-metallic collar with built-in back draft damper
- Air and sound delivery shall meet the HVI certified ratings as per the fan curves attached
- ORTECH Universal Series Fans come with a permanent split capacitor motor
- ENERGY STAR® Certified

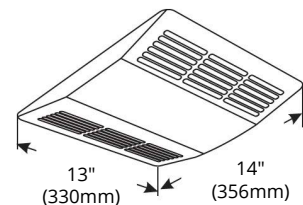
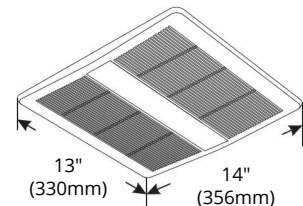

**FAN CURVES**

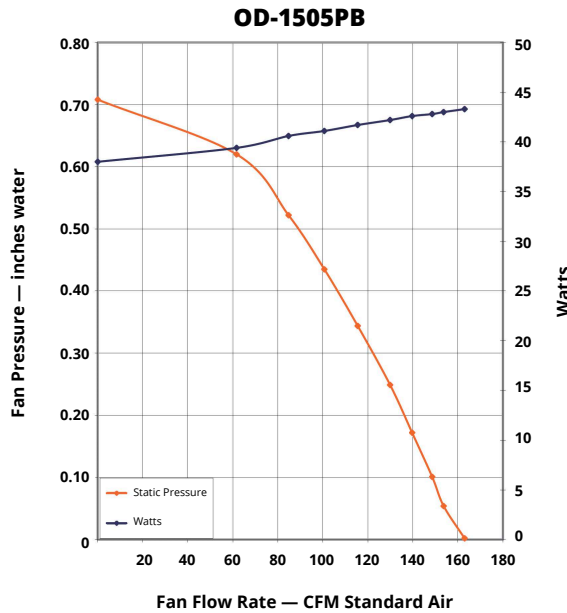
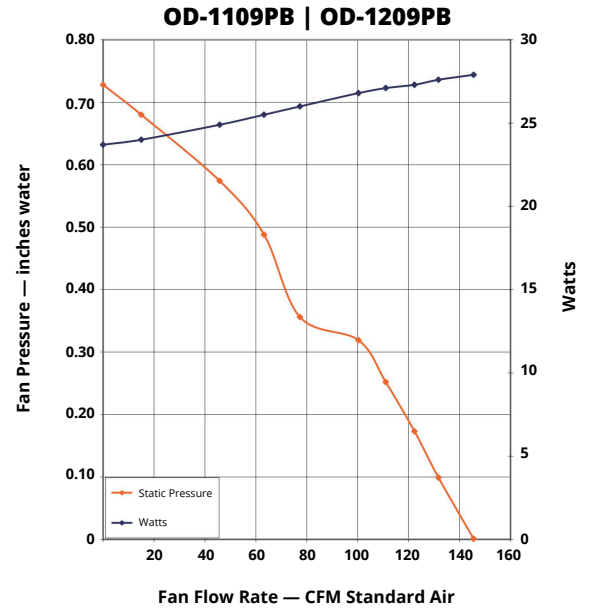
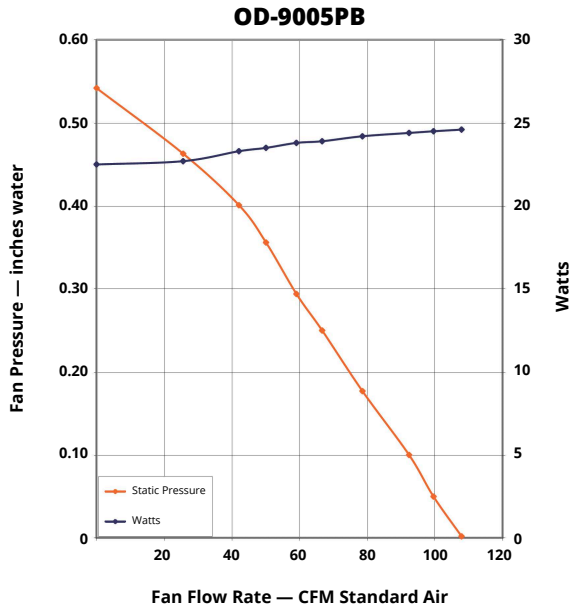

Reference	QTY.	Remarks	Project:
			Location:
			Architect:
			Engineer:
			Contractor:
			Submitted by:
			Date:

ORTECH reserves the right to modify at any time, without notice, any or all of our product's features, designs, components and specifications to meet market changes.